

Operating Guide | Warranty

Model Number | L15V26 | LCD TV



RECORD YOUR MODEL NUMBER
(Now, while you can see it)

The model and serial number of your Entertainment Machine™ are located on the back of the TV cabinet. For your future convenience, we suggest that you record these numbers here:

MODEL
NO. _____

SERIAL
NO. _____



WARNING
RISK OF ELECTRIC SHOCK
DO NOT OPEN



WARNING :

TO REDUCE THE RISK OF ELECTRIC SHOCK DO NOT REMOVE COVER (OR BACK). NO USER SERVICEABLE PARTS INSIDE. REFER SERVICING TO QUALIFIED SERVICE PERSONNEL.



The lightning flash with arrowhead symbol, within an equilateral triangle, is intended to alert the user to the presence of uninsulated "dangerous voltage" within the product's enclosure that may be of sufficient magnitude to constitute a risk of electric shock to persons.



The exclamation point within an equilateral triangle is intended to alert the user to the presence of important operating and maintenance (servicing) instructions in the literature accompanying the appliance.

WARNING :

TO PREVENT FIRE OR SHOCK HAZARDS, DO NOT EXPOSE THIS PRODUCT TO RAIN OR MOISTURE.

NOTE TO CABLE/TV INSTALLER:

This reminder is provided to call the cable TV system installer's attention to Article 820-40 of the National Electric Code (U.S.A.). The code provides guidelines for proper grounding and, in particular, specifies that the cable ground shall be connected to the grounding system of the building, as close to the point of the cable entry as practical.

REGULATORY INFORMATION:

This equipment has been tested and found to comply with the limits for a Class B digital device, pursuant to Part 15 of the FCC Rules. These limits are designed to provide reasonable protection against harmful interference when the equipment is operated in a residential installation. This equipment generates, uses and can radiate radio frequency energy and, if not installed and used in accordance with the instruction manual, may cause harmful interference to radio communications. However, there is no guarantee that interference will not occur in a particular installation. If this equipment does cause harmful interference to radio or television reception, which can be determined by turning the equipment off and on, the user is encouraged to try to correct the interference by one or more of the following measures:

- Reorient or relocate the receiving antenna.
- Increase the separation between the equipment and receiver.
- Connect the equipment into an outlet on a circuit different from that to which the receiver is connected.
- Consult the dealer or an experienced radio/TV technician for help.

CAUTION:

Do not attempt to modify this product in any way without written authorization from Zenith Electronics Corporation. Unauthorized modification could void the user's authority to operate this product. The responsible party for this product's compliance is :

Zenith Electronics Corporation,
2000 Millbrook Dr.,
Lincolnshire, IL 60069, USA
1-847-941-8000

"Entertainment Machine™" is a trademark of Zenith Electronics Corporation

206-03777

IMPORTANT SAFETY INSTRUCTIONS

Important safeguards for you and your new product

Your product has been manufactured and tested with your safety in mind. However, improper use can result in potential electrical shock or fire hazards. To avoid defeating the safeguards that have been built into your new product, please read and observe the following safety points when installing and using your new product, and save them for future reference.

Observing the simple precautions discussed in this booklet can help you get many years of enjoyment and safe operation that are built into your new product.

This product complies with all applicable U.S. Federal safety requirements, and those of the Canadian Standards Association.

1. Read Instructions

All the safety and operating instructions should be read before the product is operated.

2. Follow Instructions

All operating and use instructions should be followed.

3. Retain Instructions

The safety and operating instructions should be retained for future reference.

4. Heed Warnings

All warnings on the product and in the operating instructions should be adhered to.

5. Cleaning

Unplug this product from the wall outlet before cleaning. Do not use liquid cleaners or aerosol cleaners. Use a damp cloth for cleaning.

6. Water and Moisture

Do not use this product near water - for example, near a bath tub, wash bowl, kitchen sink, or laundry tub, in a wet basement, or near a swimming pool.

7. Accessories, Carts, and Stands

Do not place this product on an unstable cart, stand, tripod, bracket, or table. The product may fall, causing serious injury to a child or adult, and serious damage to the product. Use only with a cart, stand, tripod, bracket, or table recommended by the manufacturer, or sold with the product. Any mounting of the product should follow the manufacturer's instructions, and should use a mounting accessory recommended by the manufacturer.

8. Transporting Product

A product and cart combination should be moved with care. Quick stops, excessive force, and uneven surfaces may cause the product and cart combination to overturn.

9. Attachments

Do not use attachments not recommended by the product manufacturer as they may cause hazards.

10. Ventilation

Slots and openings in the cabinet are provided for ventilation and to ensure reliable operation of the product and to protect it from overheating, and these openings must not be blocked or covered. The openings should never be blocked by placing the product on a bed, sofa, rug, or other similar surface. This product should not be placed in a built-in installation such as a bookcase or rack unless proper ventilation is provided or the manufacturer's instructions have been adhered to.

11. Power Sources

This product should be operated only from the type of power source indicated on the marking label. If you are not sure of the type of power supply to your home, consult your product dealer or local power company. For products intended to operate from battery power, or other sources, refer to the operating instructions.

12. Power-Cord Polarization

This product is equipped with a three-wire grounding type alternating-current line plug (a plug having one blade wider than the other). This plug will fit into the power outlet only one way. This is a safety feature. If you are unable to insert the plug fully into the outlet, contact your electrician to replace your obsolete outlet. Do not defeat the safety purpose of the polarized plug.

13. Power-Cord Protection

Power-supply cords should be routed so that they are not likely to be walked on or pinched by items placed upon or against them, paying particular attention to cords at plugs, convenience receptacles, and the point where they exit from the product.



PORTABLE CART WARNING

(Continued on next page)

IMPORTANT SAFETY INSTRUCTIONS

(Continued from previous page)

14. Outdoor Antenna Grounding

If an outside antenna or cable system is connected to the product, be sure the antenna or cable system is grounded so as to provide some protection against voltage surges and built-up static charges. Article 810 of the National Electrical Code (U.S.A.), ANSI/ NFPA 70 provides information with regard to proper grounding of the mast and supporting structure, grounding of the lead-in wire to an antenna discharge unit, size of grounding conductors, location of antenna-discharge unit, connection to grounding electrodes, and requirements for the grounding electrode.

Example of Grounding According to National Electrical Code Instructions

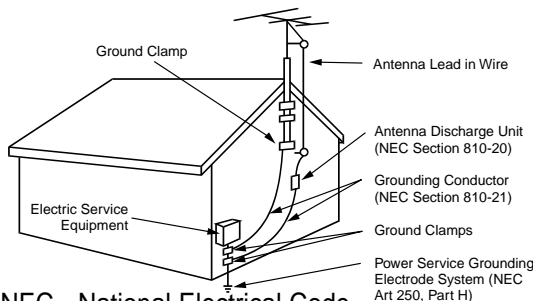

NEC - National Electrical Code

15. Lightning

For added protection for this product (receiver) during a lightning storm, or when it is left unattended and unused for long periods of time, unplug it from the wall outlet and disconnect the antenna or cable system. This will prevent damage to the product due to lightning and power-line surges.

16. Power Lines

An outside antenna system should not be located in the vicinity of overhead power lines or other electric light or power circuits, or where it can fall into such power lines or circuits. When installing an outside antenna system, extreme care should be taken to keep from touching such power lines or circuits as contact with them might be fatal.

17. Overloading

Do not overload wall outlets and extension cords as this can result in a risk of fire or electric shock.

18. Object and Liquid Entry

Never push objects of any kind into this product

through openings as they may touch dangerous voltage points or short-out parts that could result in a fire or electric shock. Never spill liquid of any kind on the product.

19. Servicing

Do not attempt to service this product yourself as opening or removing covers may expose you to dangerous voltage or other hazards. Refer all servicing to qualified service personnel.

20. Damage Requiring Service

Unplug this product from the wall outlet and refer servicing to qualified service personnel under the following conditions:

- If the power-supply cord or plug is damaged.
- If liquid has been spilled, or objects have fallen into the product.
- If the product has been exposed to rain or water.
- If the product does not operate normally by following the operating instructions. Adjust only those controls that are covered by the operating instructions as an improper adjustment of other controls may result in damage and will often require extensive work by a qualified technician to restore the product to its normal operation.
- If the product has been dropped or the cabinet has been damaged.
- If the product exhibits a distinct change in performance.

21. Replacement Parts

When replacement parts are required, be sure the service technician has used replacement parts specified by the manufacturer or have the same characteristics as the original part. Unauthorized substitutions may result in fire, electric shock, or other hazards.

22. Safety Check

Upon completion of any service or repairs to this product, ask the service technician to perform safety checks to determine that the product is in proper operating condition.

23. Wall or Ceiling Mounting

The product should be mounted to a wall or ceiling only as recommended by the manufacturer. The product may slide or fall, causing serious injury to a child or adult, and serious damage to the product.

24. Heat

The product should be situated away from heat sources such as radiators, heat registers, stoves, or other products (including amplifiers) that produce heat.

CONTENTS

INDEX

Before operating the TV, please read this manual carefully.

1	Safety precautions	2
	Controls	6
	TV Overview	10

2	Antenna Connections	13
	VCR Connections	14
	External Equipment Connections	15
	DVD Player Connections	16
	DTV (Set-top Box) Connections	17
	PC/Computer Connections (use TV as a Monitor)	18
	PC Mode Functions Check	20
	PC Mode Adjustments	21

3	Remote Control: Installing Batteries/Operation	26
	To turn the TV on	27
	TV Mode Available Menus	28
	Menu Language Selection	29
	Auto Programming: Finding/Erasing channels	30

4	Setting the Clock	32
	Setting Off Timer	33
	Setting On Timer	35
	Sleep Timer Setup	37

5	Video/Picture Setup	38
	Audio/Sound Setup	42

6	Closed Captions	48
	Parental Control	51
	Auto Off	54
	Key Lock	55

7	Specifications	56
	Maintenance	57
	Troubleshooting Check List	58
	Your Zenith Limited Warranty	Back cover

Controls

Front of the TV

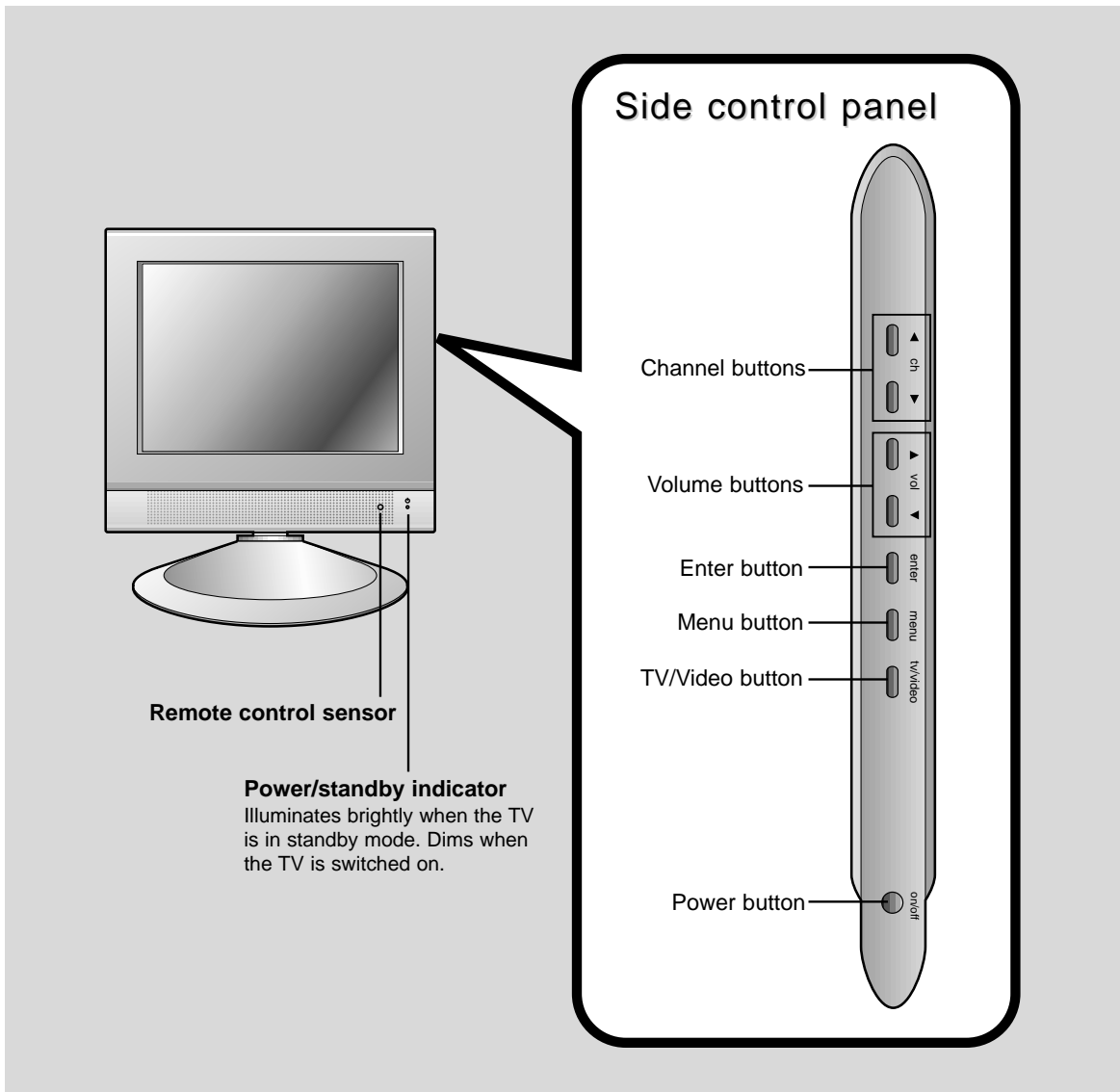

Back of the TV

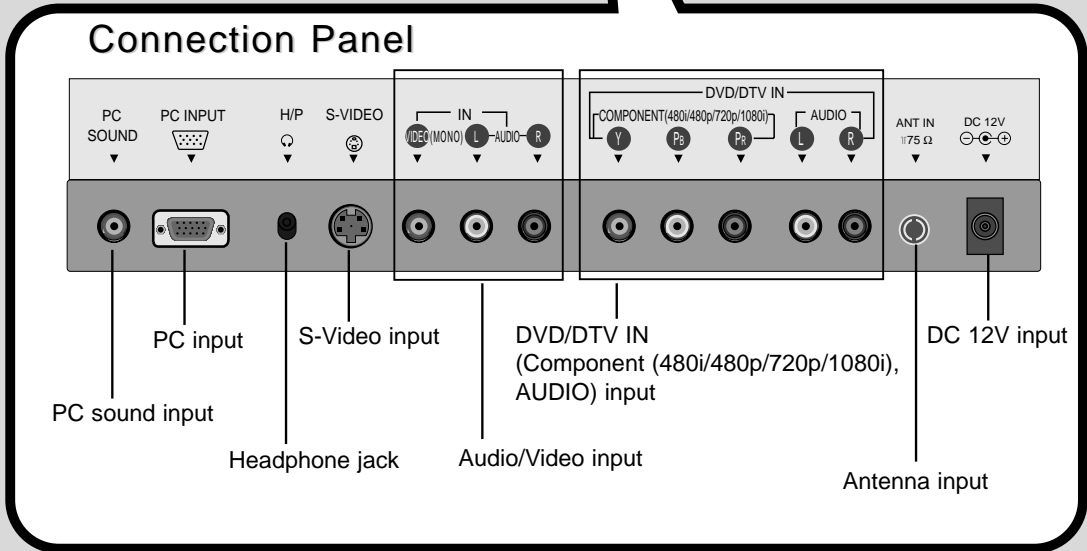
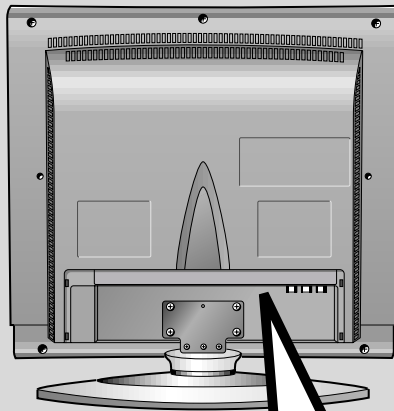

Remote Control Overview

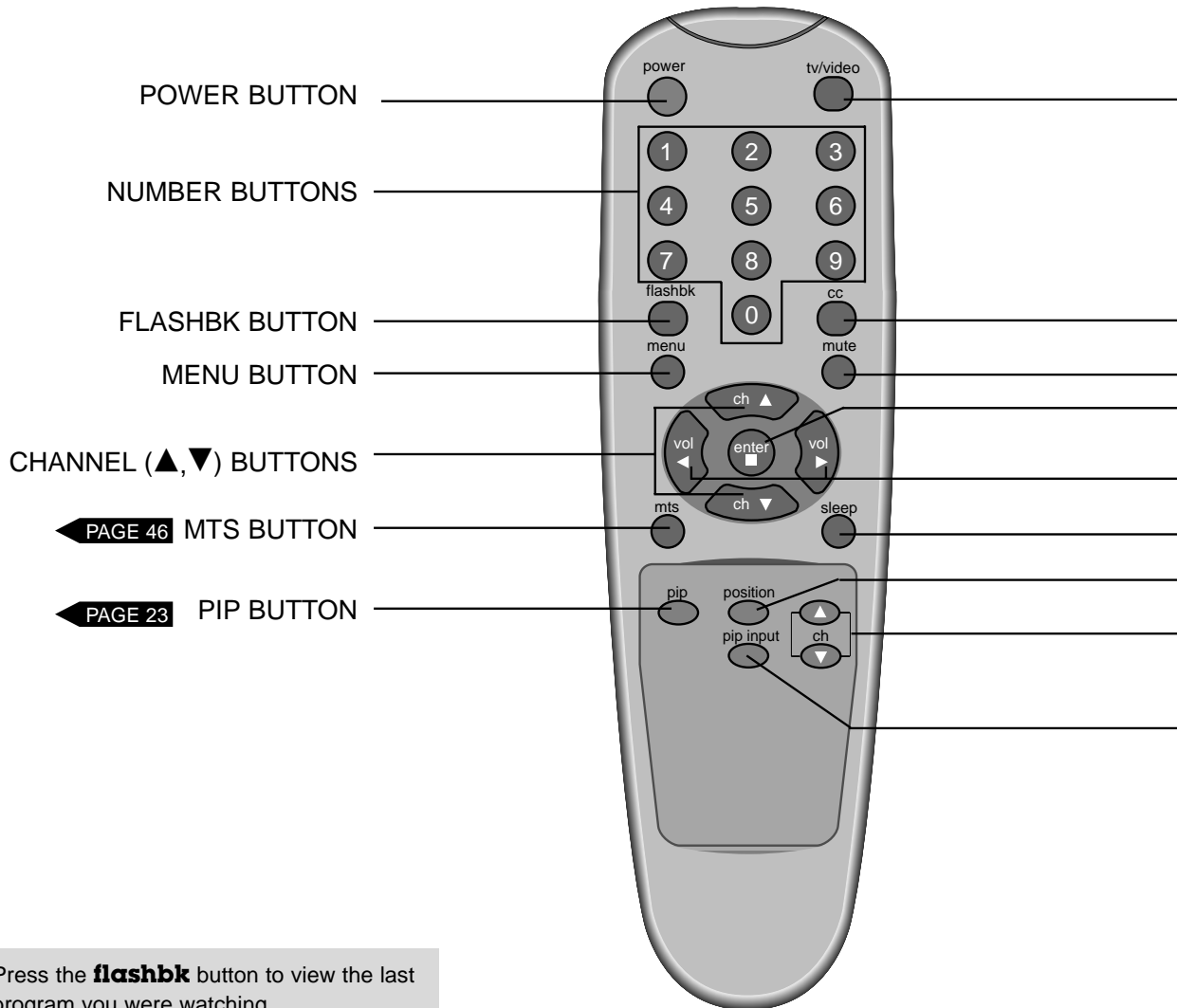

TV/VIDEO BUTTON PAGE 14-18

CAPTION BUTTON PAGE 50

MUTE BUTTON PAGE 47

ENTER BUTTON

VOLUME (◀,▶) BUTTONS

SLEEP BUTTON PAGE 37

POSITION BUTTON PAGE 24

PIP CHANNEL BUTTONS PAGE 24

PIP INPUT BUTTON PAGE 23

**TV/VIDEO button
on Remote Control**



* Each press of this button changes the viewing source as indicted below.

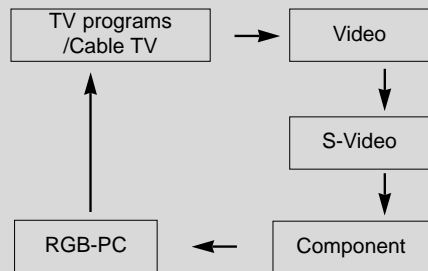

* **VIDEO, S-VIDEO, COMPONENT, PC**
: Select each mode for watching the corresponding external equipment.

TV overview

Accessories

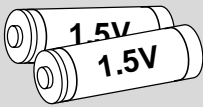

AAA
Batteries

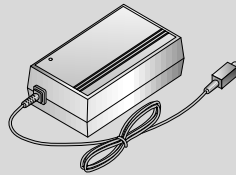

AC Adapter

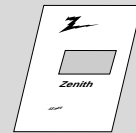

Operating guide



Power cord

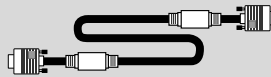

PC signal cable



PC sound cable



Remote Control



Tie band

* Arrange the device wires with the tie band.

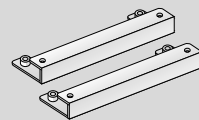

VESA compatible adaptor/ interface

* While mounting the TV on a VESA specifications mount, attach this adaptor to the back of the TV and then to the VESA mount.

Watching TV Programs

* Please make sure to connect the TV to the adapter before connecting the power plug to the wall power outlet.

- Remove the connection panel cover as shown below.
- Connect the antenna cable to the antenna input port on the TV.
- Connect the adapter to the power input port on the TV.
- Plug the power cord into the wall power outlet after connecting the power cord to the adapter.
- Reinstall the connection panel cover.

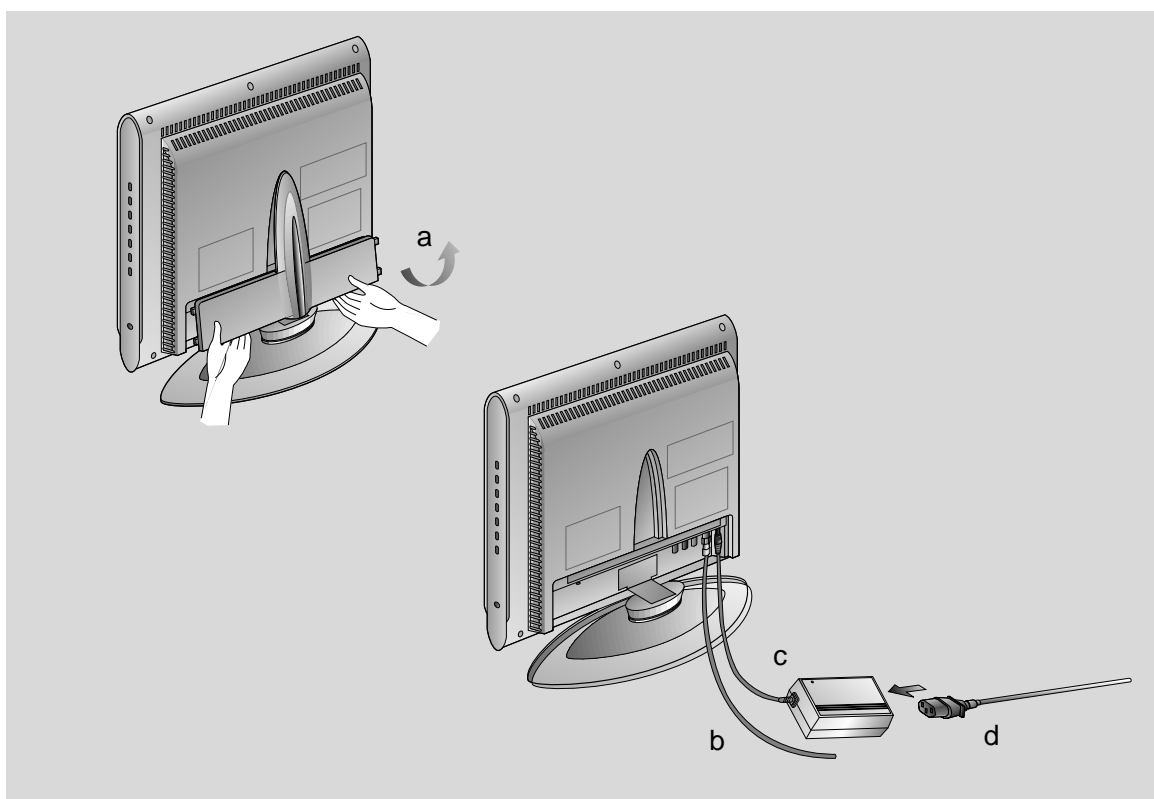

- Note :
- If the TV feels cold to the touch, there may be a small “flicker” when turned on. This is normal, there is nothing wrong with TV.
 - Some dot defects may appear on the screen, like red, green or blue spots. However, this will have no adverse effect on the monitor's performance.
 - Avoid touching the LCD screen or holding your finger(s) against it for long periods of time. Doing so may produce some temporary distortion effects on the screen.

Adjusting the TV Viewing Angle

* You can adjust the angle of the TV between 2° and 13°.

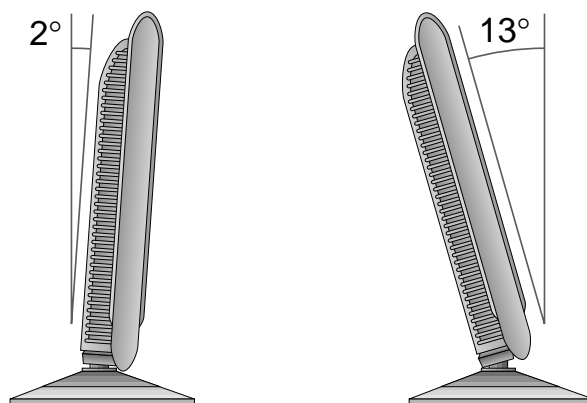

Antenna Connections

* For better picture quality, adjust antenna direction.

Connecting to wall antenna socket

- Typical wall antenna jack used in apartment buildings, connect the antenna cable as shown below. (Use the correct type of antenna cable for the type of wall antenna jack.)

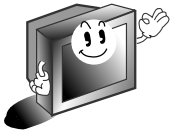
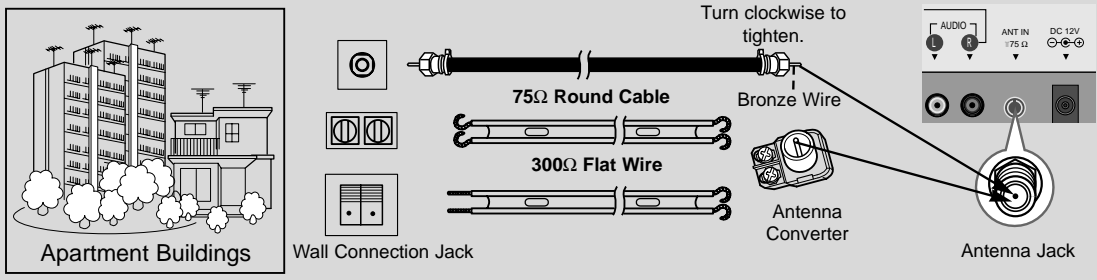

- * If you have a 75Ω round cable, insert the bronze wire and then tighten the connection nut. And if you have a 300Ω flat wire, connect the twisted wire to the antenna converter and then connect the converter to the antenna jack.
- * When using 75Ω round cable, do not bend the bronze wire. It may cause poor picture quality.

Connecting to outdoor antenna

- This type of antenna is commonly used in single family homes.

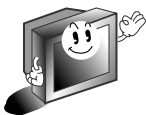
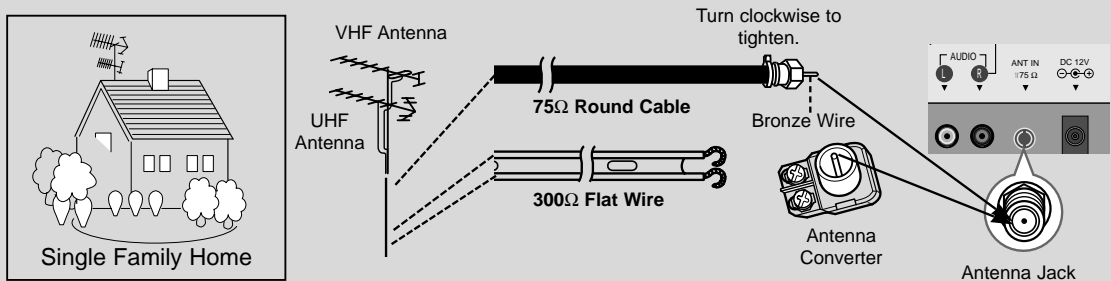

- * In poor signal areas, you can get better picture quality if you install the antenna as shown at right.
- * If antenna is split for two TVs, use "signal divider" for connection.

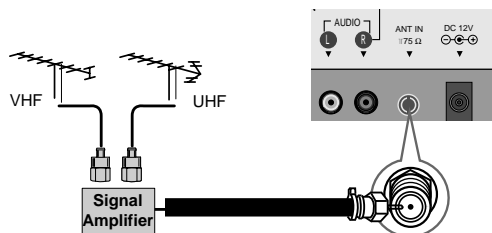

VCR Connections

- * In Video mode, TV automatically reverts to TV mode if the channel (▲, ▼) buttons or number buttons (0~9) are pressed.
- * Connect to other AV equipment using input jacks on the TV.

Connecting a VCR

1 How to connect

- Connect the audio/video output jacks on VCR to the corresponding input jacks on the TV.

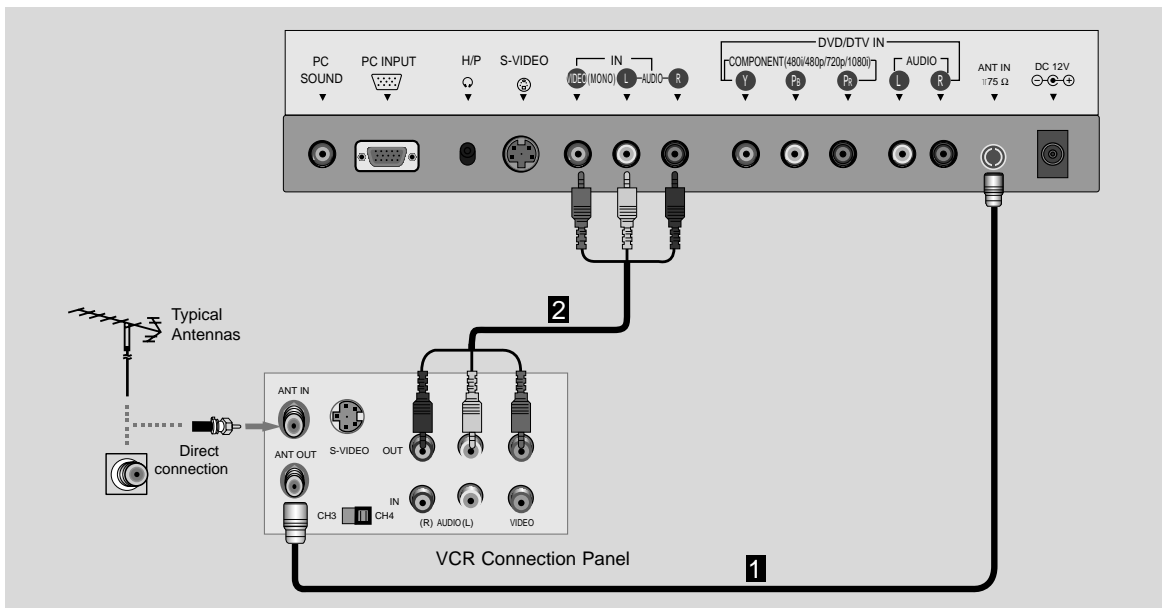

2 How to use

Watching TV programs

Turn the TV on and tune to a channel.

Watching VCR

- Press **tv/video** button of the remote control to select Video mode.
 - * Select the channel 3 or 4 for only ANT IN connection **1**.
 - * Select VIDEO to use Audio/Video In connection **2**.
- Insert a video tape into the VCR and press the PLAY button.

External Equipment Connections

Watching external A/V source

1 How to connect

- Connect the audio/video output jacks on the external A/V equipment to the corresponding input jacks on the TV.

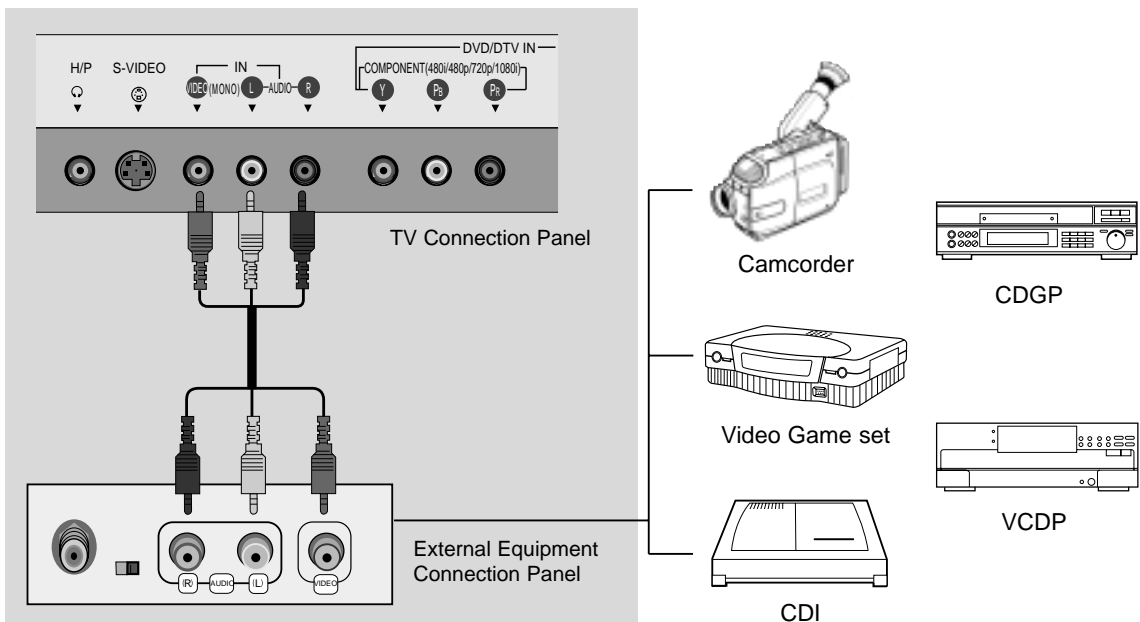

2 How to use

- Turn on the external A/V equipment.
- Turn the TV on and press **tv/video** button to select Video mode.

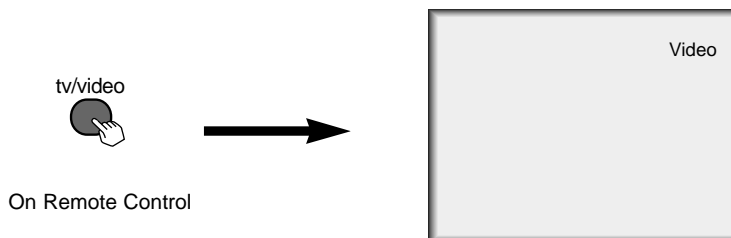

DVD Player Connections

- Connect DVD/DTV output jacks to TV's COMPONENT (480i/480p/720p/1080i), Y, Pb, Pr jacks. Connect DVD/DTV audio output jacks to right and left input jacks on TV.

1 How to connect

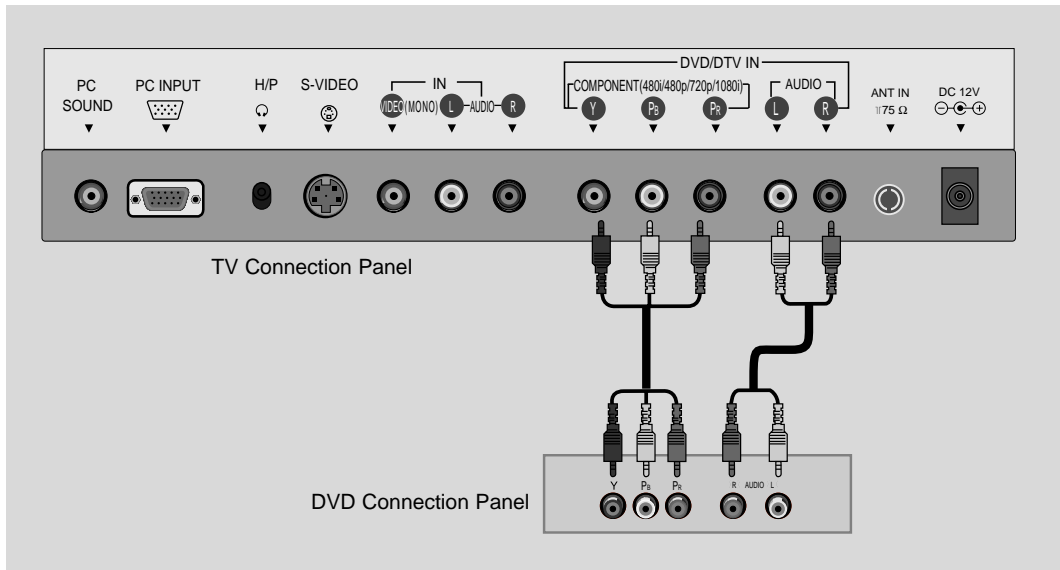

Note:

TV INPUT	Y	P _B	P _R
	↑	↑	↑
	⋮	⋮	⋮
DVD OUTPUT	Y	C _b	C _r
	Y	B-Y	R-Y
	Y	P _b	P _r
	Y	P _B	P _R

2 How to use

- Turn on the DVD player.
- Turn the TV on and use **tv/video** button to select Component source.
- See DVD/DTV user's manual for operating instructions.

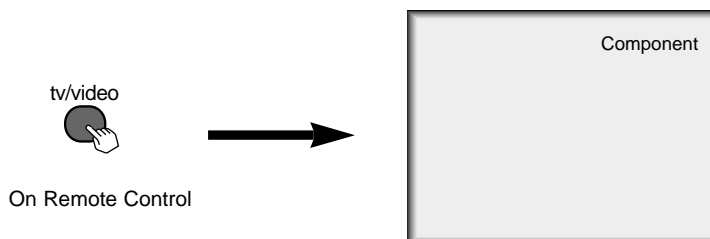

DTV (Set-top Box) Connections

- Connect DVD/DTV output to COMPONENT(480i/480p/720p/1080i), Y, P_B, P_R jack inputs on the TV. Connect DTV L/R audio outputs to the TV's AUDIO L/R input jacks.

Note: A DTV set-top box is required to receive DTV programming.

1 How to connect

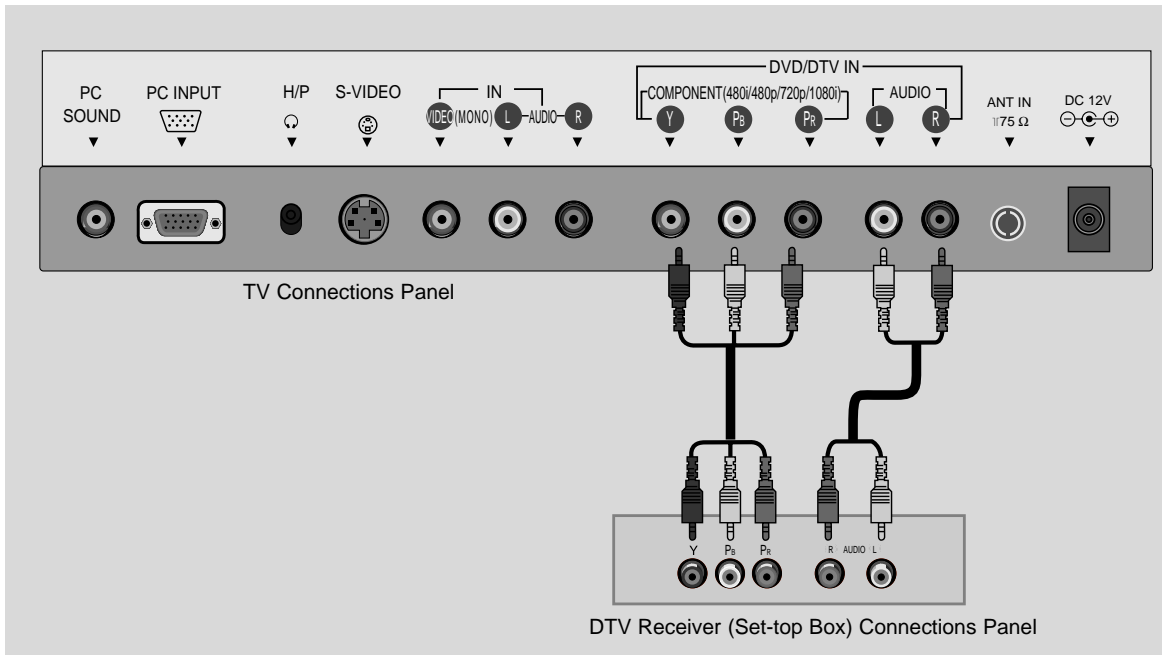

2 How to use

- Turn on the DTV receiver (Set-top Box).
- Turn the TV on and use **tv/video** button to select Component source.

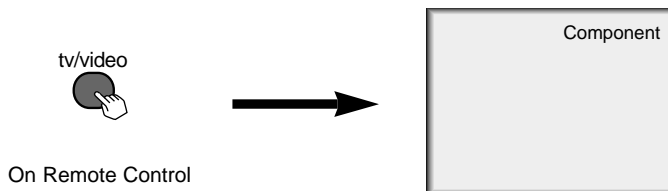

PC/Computer Connections (using TV as a Monitor)

* After setup, be sure to set TV to PC source.

1 How to connect

- Set the monitor output resolution on the PC before connecting to the TV. See the next page.
- Connect the TV to the PC with the PC cable.
- Connect the PC audio output to the TV's PC SOUND input.

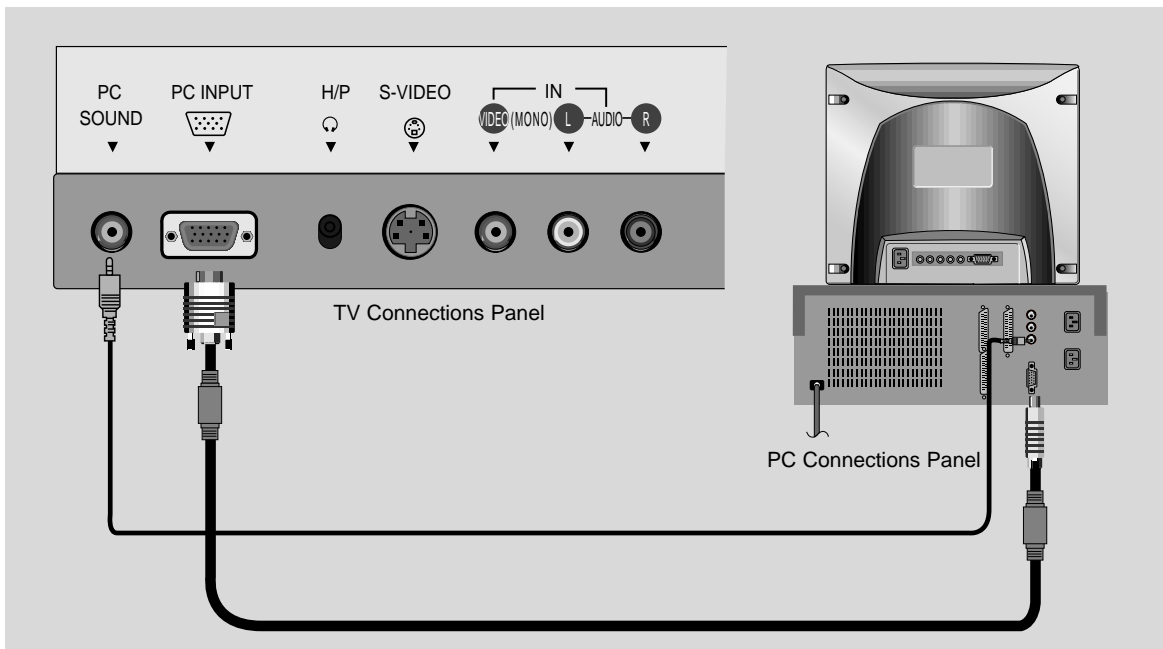

2 How to use

- Turn on the PC/Computer.
- Turn the TV on and use **tv/video** button to select RGB-PC source.

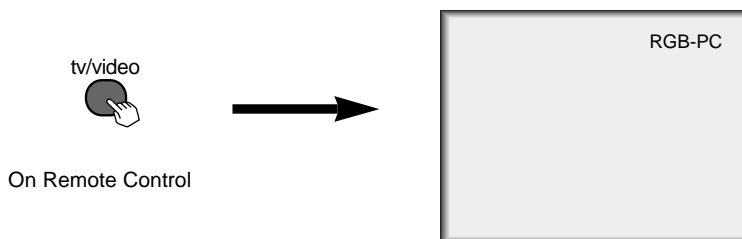

Displayable Monitor Output Format Specifications

MODE	Resolution	Horizontal Frequency (KHz)	Vertical Frequency (Hz)
VGA	640x400	31.5KHz	70Hz
	640x400	37.9KHz	85Hz
	640x480	31.5KHz	60Hz
	640x480	35.0KHz	67Hz
	640x480	37.9KHz	72Hz
	640x480	37.5KHz	75Hz
	640x480	43.3KHz	85Hz
	720x400	31.5KHz	70Hz
SVGA	800x600	35.2KHz	56Hz
	800x600	37.9KHz	60Hz
	800x600	48.1KHz	72Hz
	800x600	46.9KHz	75Hz
	800x600	53.7KHz	85Hz
	(MAC)	832x624	49.7KHz
XGA	1024x768	48.4KHz	60Hz
	1024x768	56.5KHz	70Hz
	1024x768	60.2KHz	75Hz
	1024x768	68.67KHz	85Hz

Note:

The TV has been pre-adjusted to use XGA1024x768, 60Hz format.

- a. If possible, use one of the XGA formats to obtain the best image quality for your TV/LCD monitor. If set up under other resolutions, a distorted picture may appear on the screen. If set to Vertical frequency 85Hz, some noise can be seen when PIP is on. In this case, set the Vertical frequency to 60Hz.
- b. If the message “**OUT OF RANGE**” appears on the screen, adjust the PC output to a format listed in the ‘Displayable Monitor Output Format Specifications’ chart above.

DPM (Display Power Management) mode

When the PC is in the power saving mode, to also save energy, the monitor automatically switches to DPM mode.

* Synchronization input form : Separate

PC Mode Functions Check

* After setup, be sure to set TV to PC source.

1 Press the **menu** button repeatedly to display the menus as shown below.

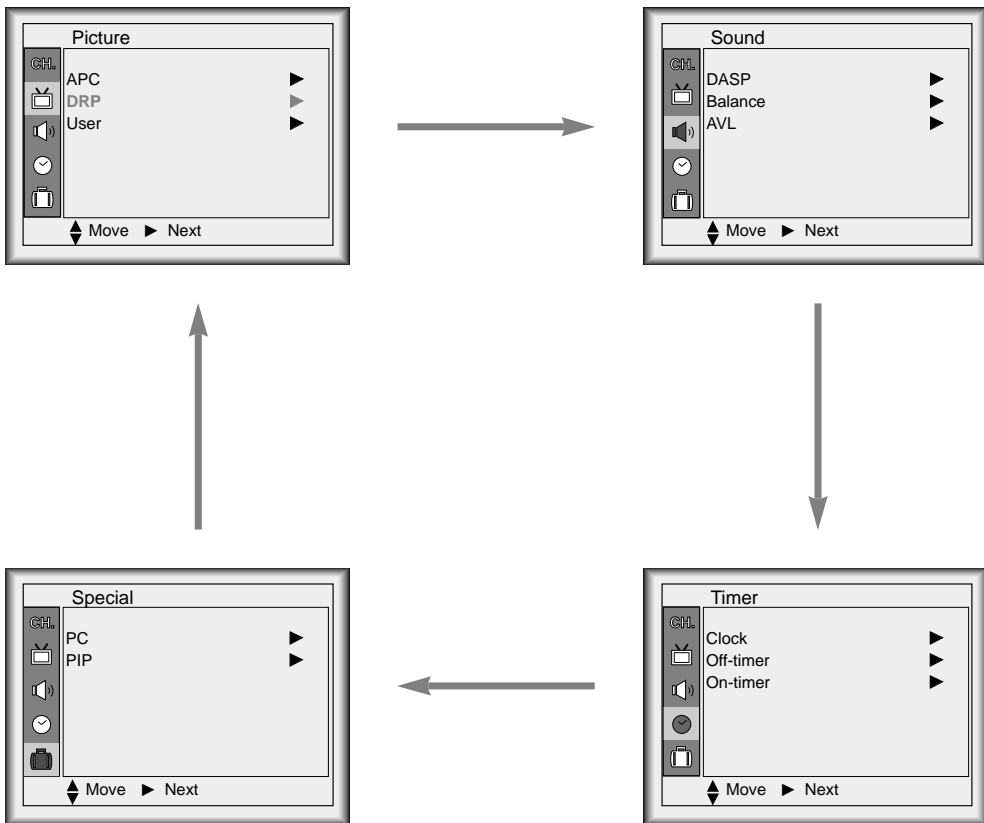

2 Use the channel (▲,▼) buttons to select menu options.

PC Mode Adjustments

* Be sure to select the PC source before operation.

PC setup

- 1 Use the **menu** button to select the Special Menu.

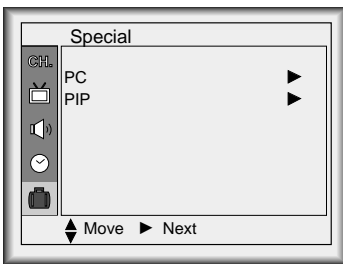

- 3 Press the volume (▶) and then use the channel (▲,▼) buttons to select an option you want to adjust.

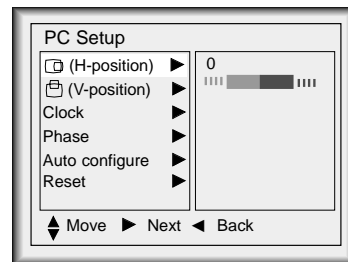

- 2 Press the volume (▶) and then use the channel (▲,▼) buttons to select the PC option.

- Each press of channel (▲,▼) buttons changes the screen display as shown below.

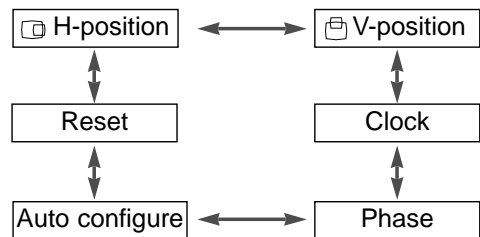

PC Mode Adjustments

- 4 Press the volume (▶) and then use the volume (◀, ▶) buttons to make appropriate adjustments.

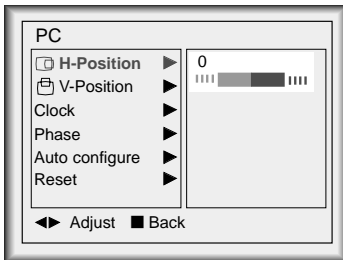

- H-Position/V-Position
: This function adjusts picture left/right and up/down.
The adjustment ranges are -100~+100 / -30~+30.
- Clock
: This function minimizes any vertical bars or stripes appearing on the screen background.
The adjustment range is -30~+30.
- Phase
: This function allows you to remove any horizontal noise and clear up or sharpen the character images.
The range adjustment is -15~+15.
- Auto-configure
: This function is for the automatic adjustment of the screen position, clock and clock phase.
(The displayed image will disappear for a few seconds while Auto-configuration is in progress.)
- Reset
: This function allows you to return to the default setting programmed at the factory; default settings cannot be changed.

-
- 5 Press the **enter** (■) button.
-

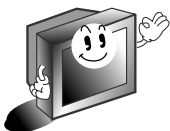

- * Some signals from some graphics boards may not function properly. If the results are unsatisfactory, adjust your monitor's position, clock and clock phase manually.
- * If you turn on PIP, you cannot access PC setup. If you need to adjust PC setup, turn off PIP first.

- * Be sure to select the PC source before operation.
- * PIP (Picture In Picture) lets you view 2 different inputs (sources) on your TV screen at the same time. One source will be large, and the other source will show a smaller inset image.

PIP (Picture In Picture) On/Off and PIP size

- 1 Press the **pip** button to turn PIP on.

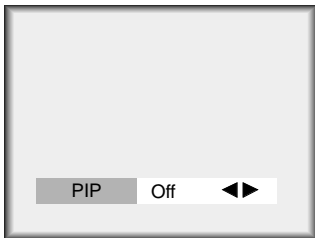

- 2 Use the **pip** button or volume (◀, ▶) buttons to select the PIP sub picture size.

- Each press of volume (◀, ▶) buttons changes the screen display as shown below.

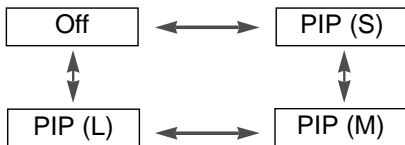

- 3 Press the **enter** (■) button.

Selecting the PIP source

- 1 Press the **pip input** button to select PIP input menu.

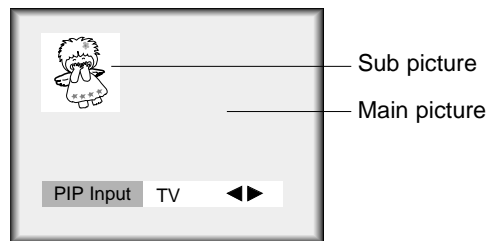

- 2 Press the **pip input** button or volume (◀, ▶) buttons to select the input source for the PIP picture.

- Each press of volume (◀, ▶) buttons changes the screen display as shown below.



- 3 Press the **enter** (■) button.

Moving the PIP sub picture

- 1 Press the **position** button.

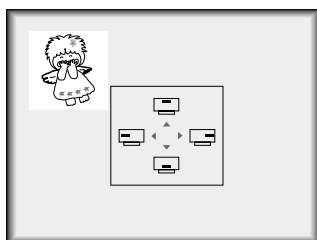

-
- 2 Press the channel (**▲, ▼**) buttons or volume (**◀, ▶**) buttons to move the PIP picture. The PIP sub picture moves up/down and left/right.

-
- 3 Press the **enter** (**■**) button.

TV Program selection for PIP sub picture

- 1 Use the **PIP ch** (**▲, ▼**) button to select a channel for PIP sub picture.

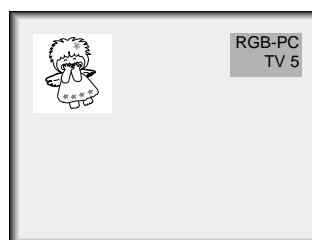

- If you press the **PIP ch** (**▲, ▼**) when selecting the Video or S-Video source for the PIP picture, input for PIP changes to TV source.

-
- 2 Press the **enter** (**■**) button.

* PIP Mode: Sound Source Selection Options

PIP sound options

- 1 Use the **menu** button to select the Special menu.

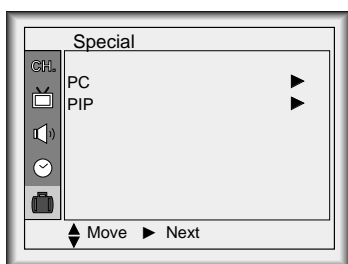

- 2 Press the volume (▶) and use the channel (▲,▼) buttons to select the PIP option.

- 3 Press the volume (▶) and then use the channel (▲,▼) buttons to select the Sound option.

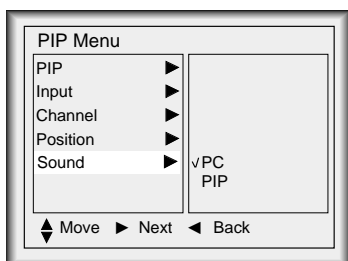

- 4 Press the volume (▶) and then use the channel (▲,▼) buttons to select: main picture sound [PC] or sub picture sound [PIP].

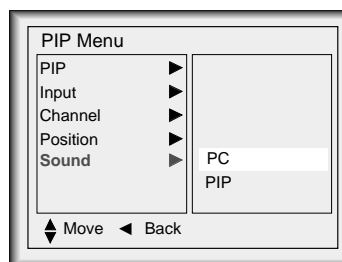

- Each press of channel (▲,▼) buttons changes the screen display as shown below.



- 5 Press the **enter** (■) button.

Remote Control: Installing Batteries/Operation

Installing batteries

- 1 Pull the battery cover upward in the direction shown by the arrow and remove it.

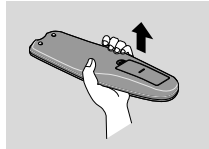

- 2 Insert the batteries with correct polarity.

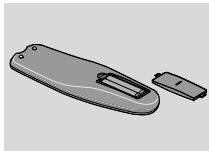

- 3 Replace the battery compartment cover.

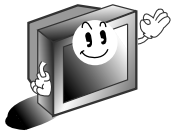
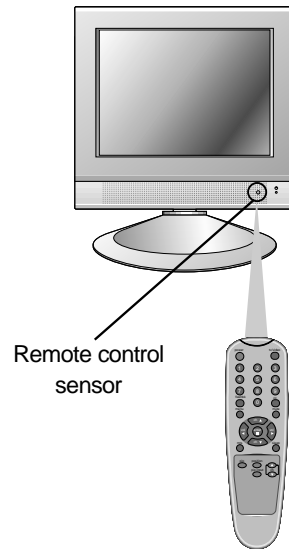
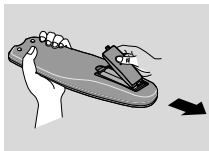

- * Install two 1.5V alkaline batteries of AAA type. Don't mix the used batteries with new batteries.
- * Remove batteries when you don't use the remote control for a long time. Liquid leakage from old batteries may damage the remote.

Notes for using remote control

Make sure there are no objects between the remote control and its sensor.



Don't place the remote control near a heater or in a damp place. A strong impact on remote control may damage it.

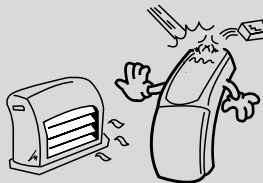

Signal from the remote control may be disturbed by sun light or other strong light. In this case, darken the room.

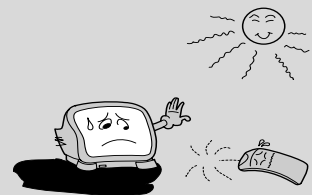

To turn the TV on

TV Operation Overview

1 First, connect antenna cable and power cord with the adapter. Press **on/off** on the TV side panel.

- Press **power** on the remote control to put the TV into standby mode. In standby mode, press the **power**, **ch** (▲,▼), **tv/video** and **number** button on the remote control or **ch** (▲,▼), **tv/video** on the TV side panel to turn on it fully.

2 Select the viewing source by pressing **tv/video** on the remote control.

- Note: See page 30 if you have not auto programmed the TV to receive channels in your local broadcast area.

3 After viewing, press the **power** button on the remote control. The TV reverts to standby mode. Press the **on/off** on the TV side panel again to turn off the TV.

Watching TV programs

1 Press **power** on the remote control to turn the TV on.

2 Use the channel (▲,▼) or number buttons to select a channel to view.

3 Adjust Volume level.

- Volume (▶) button increases the sound level.
- Volume (◀) button decreases the sound level.

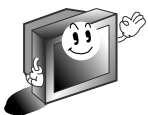
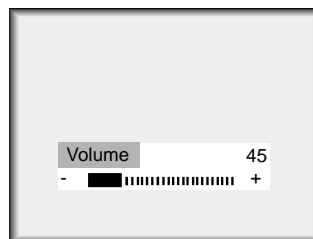

* If you want to turn off the TV, press the on/off button on the side panel of the TV. If you will be away on vacation, disconnect the power plug to the wall power outlet.

TV Mode Available Menus

1 Press the **menu** button repeatedly to display the available menus shown below.

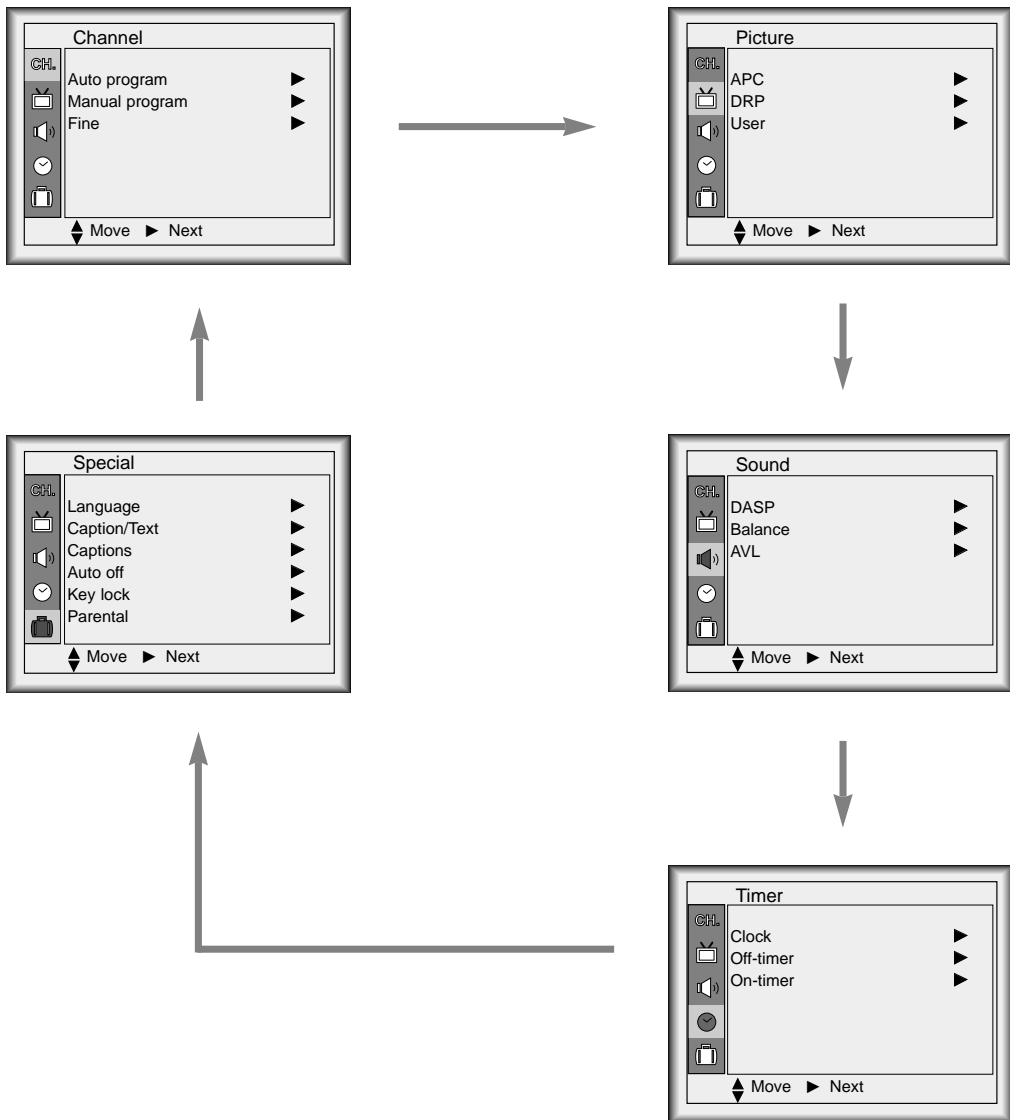

2 Use the channel (▲,▼) buttons to select a menu option.

Menu Language Selection

Language

- 1 Use the **menu** button to select the Special menu.

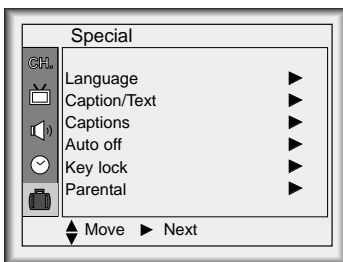

- 3 Press the volume (▶) and then use the channel (▲,▼) buttons to select a language for the menus to appear in.

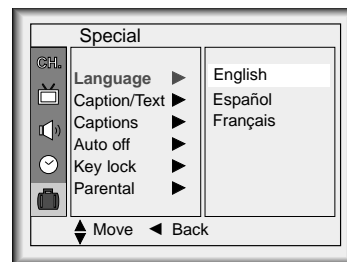

- Each press of channel (▲,▼) buttons changes the screen display as shown below.

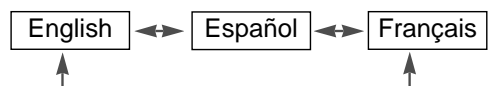

- 2 Press the volume (▶) and then use the channel (▲,▼) buttons to select the Language option.

- 4 Press the **enter** (■) button.

Auto Programming: Finding/Erasing Channels

Channel Search (Auto Programming)

* For Auto program to work, the programming source must be connected to the TV and the TV must be receiving programming signals either over-the-air or from a cable-type service provider. (See page 7.)

- 1 Use the **menu** button to select the Channel menu.

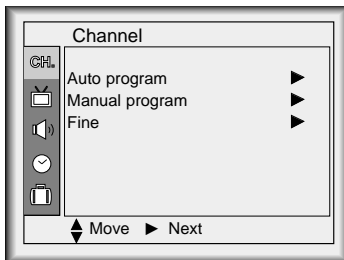

- 3 Press the volume (▶) button to begin the channel search.

- Wait for auto program to complete the channel search cycle before choosing a channel. The TV scans for over-the-air channels and then channels provided by a cable service.

- 2 Press the volume (▶) and then use the channel (▲,▼) buttons to select the Auto program option.

Memorizing channel number is displayed.

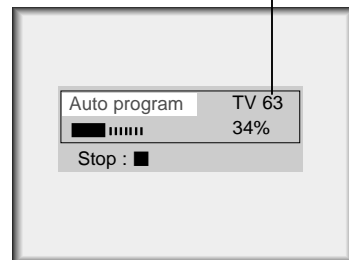

- 4 Press the **enter** (■) button.

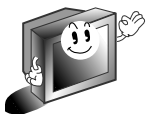

- * When the channel search is complete, use the channel (▲,▼) buttons to review the memorized channels.
- * If you press the **enter** (■) button in auto programming, the function will stop and only channels programming up to that time will remain.
- * Auto programming function can memorize only the channels which are being received at that time.

Memorizing/Erasing channels

*You can select **Memory** (to add the channel) or **Erase** (to delete the channel from memory).

- 1** Use the **menu** button to select the Channel menu.

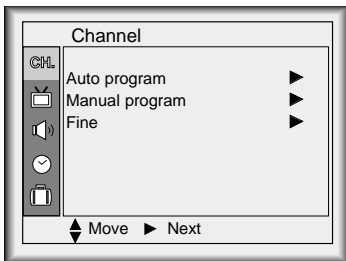

- 4** Press the channel (**▲,▼**) button and then use the volume (**◀,▶**) buttons to select Memory (add) or Erase (delete).

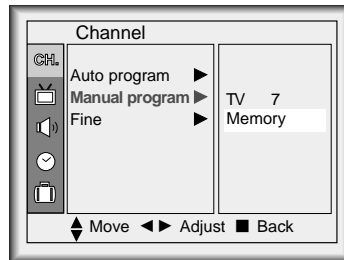

- 2** Press the volume (**▶**) and then use the channel (**▲,▼**) buttons to select the Manual program option.

- Each time you press the volume (**◀,▶**) buttons, you toggle between Memory and Erase, as shown.

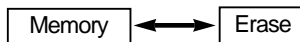

- 3** Press the volume (**▶**) button and then press the volume (**◀,▶**) buttons to select a channel you want to add to memory or erase.

The current channel number is displayed.

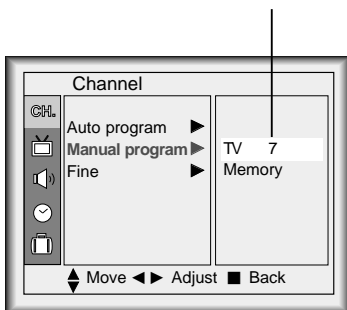

- 5** Press the **enter** (**■**) button.

- The current channel is added to Memory or Erased from the channel list.

Setting the Clock

* If current time setting is erased by a power failure or if TV is unplugged, reset the clock.

To set current time as 10:30 AM

- 1 Use the **menu** button to select the Timer menu.

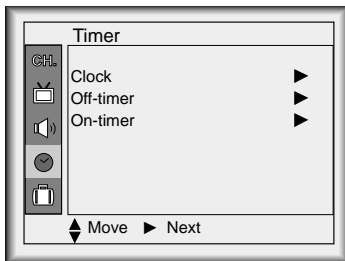

- 2 Press the volume (▶) and then use the channel (▲,▼) buttons to select the Clock option.

- 3 Press the volume (▶) and then use the channel (▲,▼) buttons to set the current hour.

- Set AM 10.

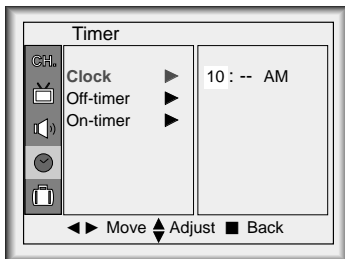

- 4 Press the volume (▶) and use the channel (▲,▼) buttons to set the current minute.

- If you hold the channel (▲) button, the minute display is changed in the sequence of 00 → 01 → 02 ...58 → 59, and changed in the reverse sequence for channel (▼) button.
- Select 30.

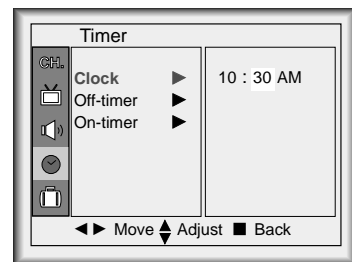

- 5 Press the **enter** (■) button.

- The clock starts when you press the **enter** (■) button.

Setting the Off Timer

*Timer function operates only if current time has been already set.

*Off-timer function overrides on-timer function if they are set to the same time.

Setup to turn the TV off at 11:30 p.m.

- 1 Use the **menu** button to select the Timer menu.

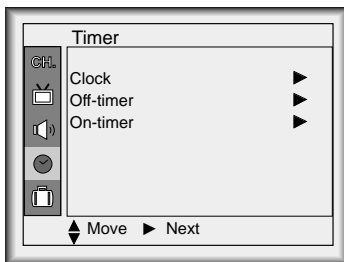

- 3 Press the volume (▶) and use the channel (▲,▼) buttons to set the turn-off hour.

- Set PM 11.

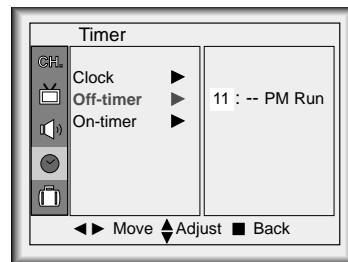

-
- 2 Press the volume (▶) and then use the channel (▲,▼) buttons to select the Off timer option.

Setting the Off Timer

(Continued from previous page)

4 Press the volume (▶) and use the channel (▲,▼) buttons to set the minutes.

- If you hold the channel (▲) button, the minute display is changed in the sequence of 00 → 01 → 02 ...58 → 59, and changed in the reverse sequence for channel (▼) button.
- Set 30.

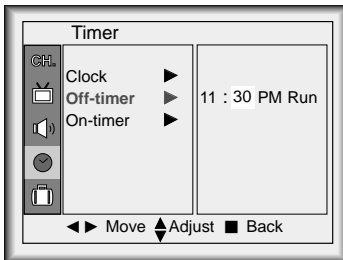

5 Use the volume (▶) button to select Hold or Run.

- Hold, Off Timer will not work.
Run, Off Timer will work.

6 Use the channel(▲,▼) buttons to select Run.

- Each press of channel (▲,▼) button changes the screen display as below.



- The screen display will disappear if you press the **enter** (■) button one more time.

7 Press the **enter** (■) button.

- Time is progressed from the point of pressing the **enter** (■) button.

Setting the On Timer

*Timer function operates only if current time has been already set.

Setup to turn the TV on at 7:10 a.m., tune TV to channel 8, with volume set at 40.

- 1 Use the **menu** button to select the Timer menu.

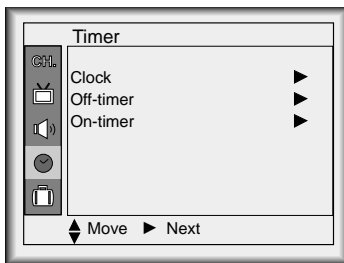

- 3 Press the volume (►) and then use the channel (▲,▼) buttons to select hour you want to set.

- Select AM 7.

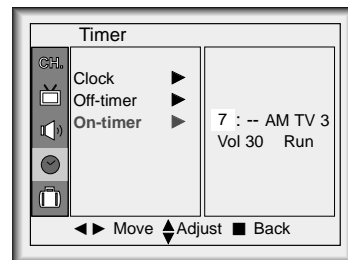

-
- 2 Press the volume (►) and then use the channel (▲,▼) buttons to select the On timer option.

Setting On-Timer function

(Continued from previous page)

4 Press the volume (▶) and then the channel (▲,▼) buttons to select minute you want to set.

- If you hold the channel (▲) button, the minute display changes in the following sequence of 00 → 01 → 02 ...58 → 59, and changes in the reverse sequence using channel (▼) button.
- Select 10.

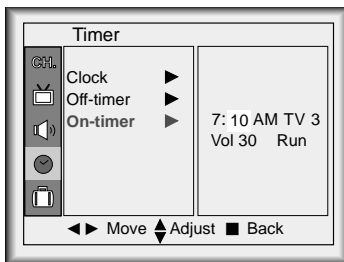

5 Press the volume (▶) button and then use the channel (▲,▼) buttons to select the channel at turn-on.

- Select TV 8.

6 Press the volume (▶) button and then use the channel (▲,▼) buttons to select the volume you want.

- Select Vol 40.

7 Press the volume (▶) button and then use the channel (▲,▼) buttons to select Hold or Run.

- Each press of channel (▲,▼) button changes the screen display as shown below.



8 Press the **enter** (■) button.

- On-Timer setup is complete.



* If on-timer function is active (Run), the current channel will change to the set channel when on-timer is activated.

* Unless a button is pressed within two hours after the TV is turned on by the on-timer function, the TV will automatically turn off.

* TV must be in standby mode for the On timer to work.

Sleep Timer Setup

* Sleep timer turns the TV off at the preset time.

1 Use the **sleep** button to set sleep timer.

- Each press of the sleep button changes the setting as shown below.

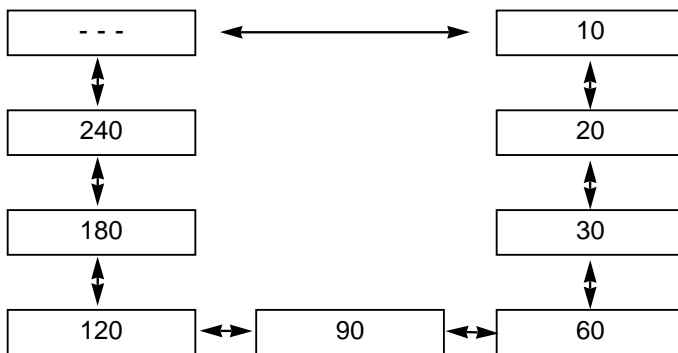

- To cancel sleep time setting, press the **sleep** button repeatedly to select [---].
- The screen display of SLEEP appears on the screen for 20 seconds prior to TV turn off.



CLOCK
SETTING

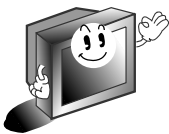

- * When the sleep time you want is displayed on the screen, don't press the **sleep** button again.
- * To check the remaining sleep time, press the **sleep** button once.
- * To change sleep time setting, press the **sleep** button repeatedly to select time setting you want.
- * If you turn the TV off after setting the sleep timer, the setting will be erased.

Video/Picture Setup

* APC adjusts the TV to the best picture appearance.

APC (Auto Picture Control)

- 1 Use the **menu** button to select the Picture menu.

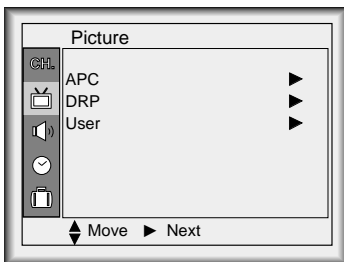

- 3 Press the volume (▶) and then use the channel (▲,▼) buttons to select your desired picture appearance.

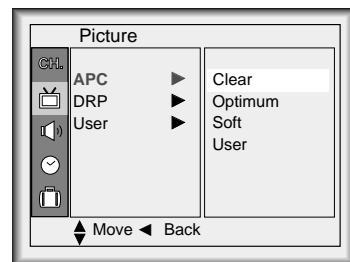

- Each press of channel (▲,▼) buttons changes the screen display as shown below.

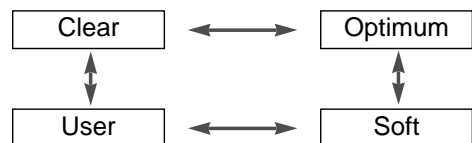

- 2 Press the volume (▶) and then use the channel (▲,▼) buttons to select the APC option.

- 4 Press the **enter** (■) button.

* DRP improves picture outline dark in areas.

DRP (Digital Reality Picture)

- 1 Use the **menu** button to select the Picture menu.

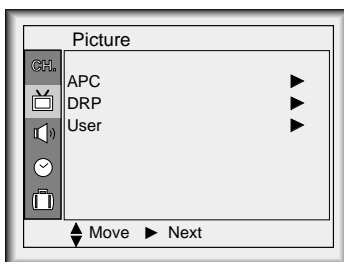

- 3 Press the volume (▶) and then use the channel (▲,▼) buttons to select Clear or Soft.

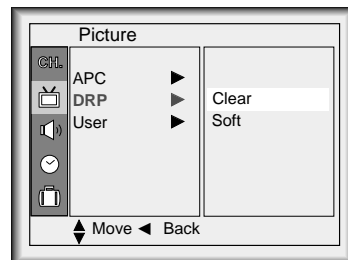

- 2 Press the volume (▶) and then use the channel (▲,▼) buttons to select the DRP option.

- 4 Press the **enter** (■) button.

Manual picture control (User Option)

- 1 Use the **menu** button to select the Picture menu.

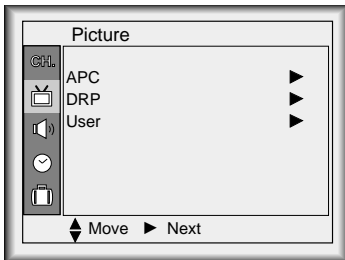

- 4 Press the volume (▶) and then use the volume (◀, ▶) buttons to make appropriate adjustments.

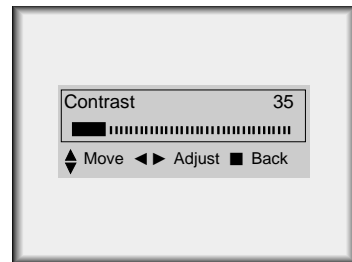

- 2 Press the volume (▶) and then use the channel (▲, ▼) buttons to select the User option.

- Use the channel (▲, ▼) button to select another option.
- Contrast, Brightness, Sharpness and Color are adjustable from 0 to 100.
- Tint is adjustable from Red 50 to Green 50.

- 3 Press the volume (▶) and then use the channel (▲, ▼) buttons to select a picture option to adjust.

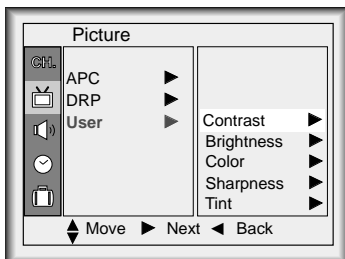

- 5 Press the **enter** (■) button.



* APC is cancelled if you set User options.

* This function adjusts the pictures stability and condition when it is poor.

Fine tuning adjustment

- 1 Use the **menu** button to select the Channel menu.

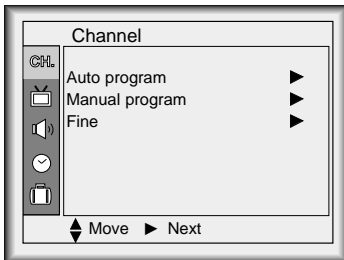

- 3 Press the volume (▶) and then use the volume (◀, ▶) buttons to adjust the picture appearance to your preference.

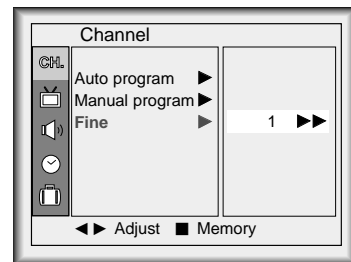

- 2 Press the volume (▶) and then use the channel (▲, ▼) buttons to select the Fine option.

- 4 Press the **enter** (■) button.

Audio/Sound Setup

*This function selects the sound appropriate to your viewing program.

DASP

- 1 Use the **menu** button to select the Sound menu.

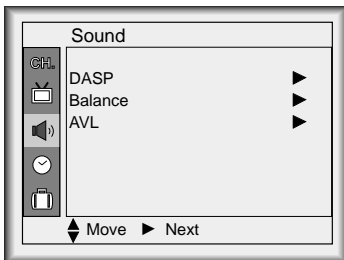

- 3 Press the volume (▶) and then use the channel (▲,▼) buttons to select the desired setting for the sound.

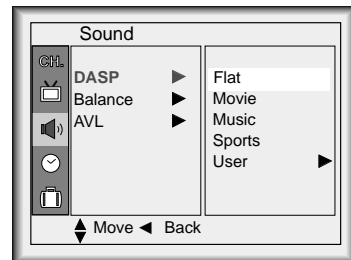

- Each press of channel (▲,▼) button changes the screen display as indicated.

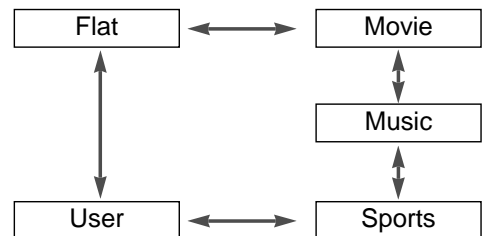

- 2 Press the volume (▶) and then use the channel (▲,▼) buttons to select the DASP option.

- 4 Press the **enter** (■) button.

Equalizer Adjustments

- 1 Use the **menu** button to select the Sound menu.

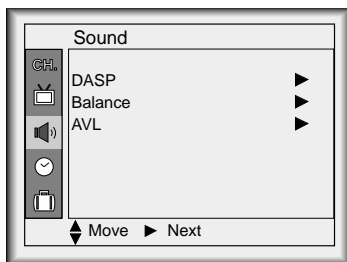

- 2 Press the volume (▶) and then use the channel (▲,▼) buttons to select the DASP option.

- 3 Press the volume (▶) and then use the channel (▲,▼) buttons to select the User option.

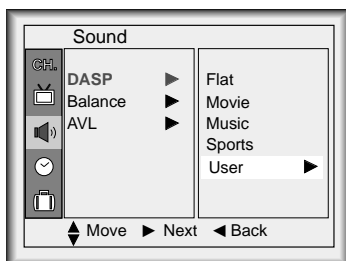

- 4 Press the volume (▶) button, then use the volume (◀, ▶) buttons to select the band you want to adjust and then use the channel (▲,▼) buttons to adjust the band level.

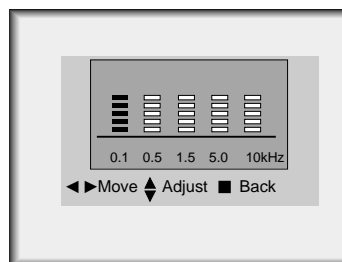

- 5 Press the **enter** (■) button.

Sound balance

- 1 Use the **menu** button to select the Sound menu.

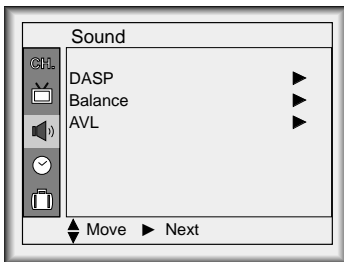

- 3 Press the volume (▶) and then use the volume (◀, ▶) buttons to adjust the balance.

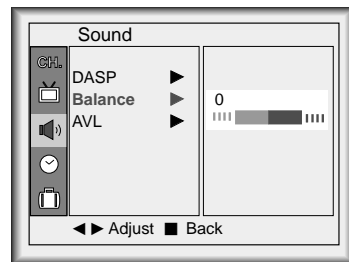

- Balance is adjustable from Left 50 to Right 50.

-
- 2 Press the volume (▶) and then use the channel (▲, ▼) buttons to select the Balance option.

-
- 4 Press the **enter** (■) button.

* AVL maintains an equal volume level automatically even if the channel is changed.

AVL (Auto Volume Leveler)

- 1 Use the **menu** button to select the Sound menu.

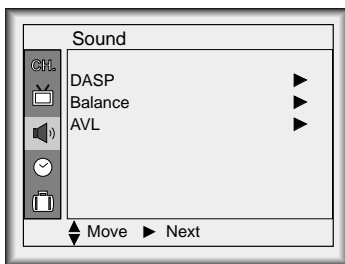

- 3 Press the volume (▶) and then use the channel (▲,▼) buttons to select On or Off.

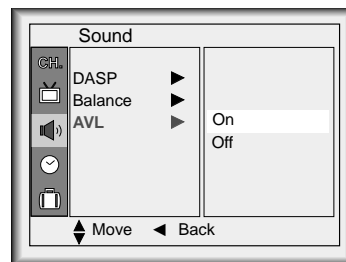

- 2 Press the volume (▶) and then use the channel (▲,▼) buttons to select the AVL option.

- 4 Press the **enter** (■) button.

Selecting Bilingual Signal (Second Audio Program)

On-screen display in stereo mode : STEREO

On-screen display in bilingual mode : SAP

* Bilingual (second audio program) signal

- This signal contains the secondary language signal in addition to the primary language.
- There are primary and secondary language and stereo modes in bilingual signals.
- [MONO] : The primary language is heard from left and right speakers in mono sound.
- [STEREO] : The primary language is heard from left and right speakers in stereo sound.
- [SAP] : The secondary language is heard from both left and right speakers in mono sound.

1 Use the **mts** button to select MTS mode.

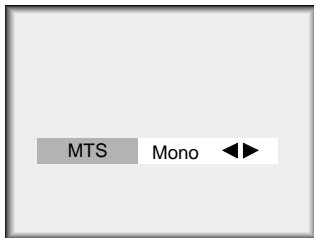

2 Use the **mts** button or volume (◀, ▶) buttons to change the audio mode.

- Each press of volume (◀, ▶) buttons changes the audio mode as shown below.

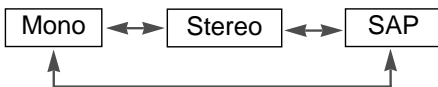

3 Press the **enter** (■) button.

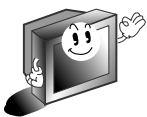

- * Select sound mono mode if the signal is not clear or in poor signal reception areas.
- * STEREO and MONO modes are available only if included on the broadcast signal.

Mute

- * Mute toggles the sound On and Off. Using mute is convenient if the user needs to answer a phone call, while viewing the TV.

Press the **mute** button.



- To restore the sound, press the **mute** button or volume (◀, ▶) buttons.
- When the sound is restored, the current volume level is displayed on the screen.

Using headphone

- Headphones are an optional feature.
- You can adjust the sound to headphones using the volume (◀, ▶) buttons. While you are listening to sound through headphones, speakers are not heard.

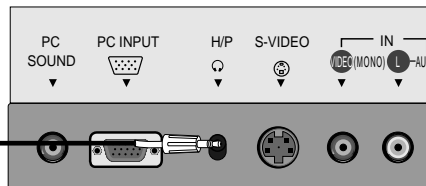

Closed captions

Closed captioning is a process which converts the audio portion of a television program into written words which then appear as subtitles on the television screen. Closed captions allow viewers to read the dialogue and narration of television programs.

Using Closed Captions

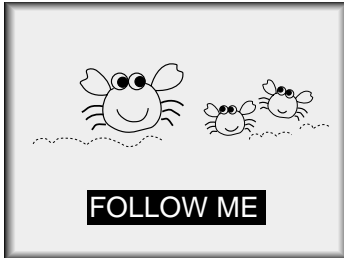

Captions are the subtitles of the dialogue and narration of television programs. For prerecorded programs, program dialogue can be arranged into captions in advance. It's possible to caption a live program by using a process called real-time captioning, which creates captions instantly. Real-time captioning is normally done by professional reporters using a machine shorthand system and computer for translation into English.

Captioning is an effective system for the hearing-impaired, and it can also aid in teaching language skills.

- The picture at left shows a typical caption.

Caption Tips

- Not all TV broadcasts include closed caption signals.
- Sometimes TV stations broadcast four different caption signals on the same channel. By selecting **From CC 1 to CC 4**, you can choose which signal you view. **CC 1** is usually the signal with the captions, while **Another mode** might show demonstration or programming information.
- Your TV might not receive caption signals normally in the following situations.

1 Poor reception conditions are encountered:



- **IGNITION:**
Picture may flutter, drift, suffer from black spots, or horizontal streaking. Usually caused by interference from automobile ignition systems, neon lamps, electrical drills, and other electrical appliances.



- **GHOSTS:**
Ghosts are caused when the TV signal splits and follows two paths. One is the direct path and the other is reflected off tall buildings, hills or other objects. Changing the direction or position of the antenna may improve reception.



- **SNOW:**
If your receiver is located at the weak, fringe area of a TV signal, your picture may be marred by small dots. It may be necessary to install a special antenna to improve the picture.

- 2 An old, bad or illegally recorded tape is played.
- 3 Strong, random signals from a car or airplane interfere with the TV signal.
- 4 The signal from the antenna is weak.
- 5 The program wasn't captioned when it was produced, transmitted, or taped.

Operating the Captions

- 1 Use the **menu** button to select the Special menu.

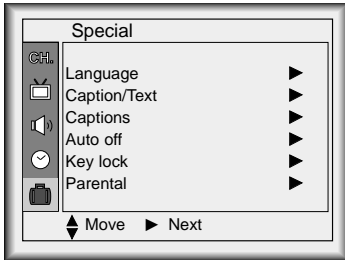

- 2 Press the volume (▶) and then use the channel (▲,▼) buttons to select the Caption/Text option.

- 3 Press the volume (▶).

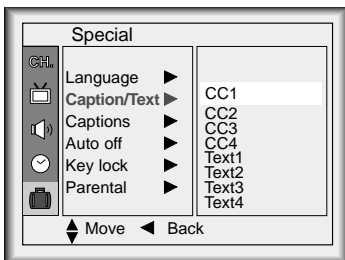

- Each time you press the channel (▲,▼) buttons, the caption mode is changed one by one as shown below.

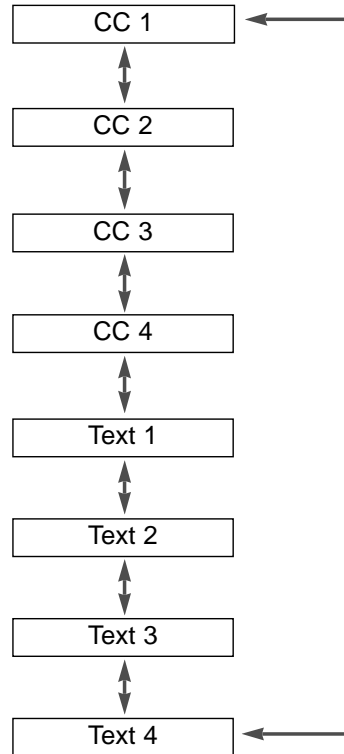

- 4 Press the **enter** (■) button.

- This TV is programmed to remember the caption/text mode it was last set to, when you turn the POWER off.

Closed Captions

Captions Setup

- 1 Use the **CC** button to select Captions.

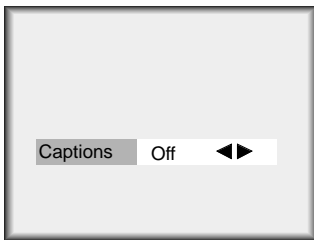

- 2 Press the **CC** button or the volume (**◀, ▶**) buttons to select On and press the **enter** (**■**) button.

- Each press of volume (**◀, ▶**) buttons changes the caption option as shown below.

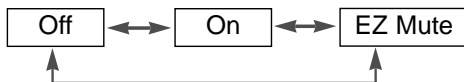

- Captions setup is complete.

Text Setup

Text services give a wide variety of information on all kind of subjects (ex. captioned program lists, weather forecasts, stock exchange topics, news for hearing-impaired---) on up to half of the TV screen. But not all stations offer text services, even though they might offer captioning.

- In the event you are receiving a poor signal, an empty black box may appear and disappear, even when the text mode is selected. This is normal function in such an event.

- 1 Repeat steps 1-3 on page 49.

- 2 Use the channel (**▲, ▼**) buttons to select: Text 1, Text 2, Text 3, or Text 4.

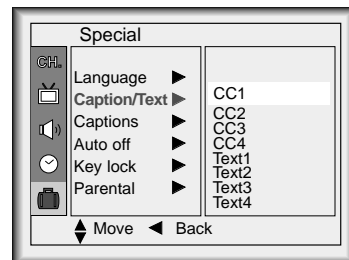

- 3 Press the **enter** (**■**) button.

Parental Control

The Parental Control Function (V-Chip) is used to block program viewing based on the ratings sent by the broadcast station. The default setting is to allow all programs to be viewed. Viewing can be blocked by the type of program and by the categories chosen to be blocked. It is also possible to block all program viewing for a time period. To use the Parental Control Function, the following must be set :

1. Ratings and categories to be blocked.
2. Number of hours to lock the television viewing control
3. Set a password
4. Enable the lock

V-Chip rating and categories

Rating guidelines are provided by broadcast stations. Most television programs and television movies can be blocked by TV Rating and/or Individual Categories. Movies that have been shown at the theaters or direct-to-video movies use the Movie Rating System(MPAA) only.

For Movies previously shown in theaters:

Movie Ratings:

- * Unblocked
- * G and Above (general audience)
- * PG and Above (parental guidance suggested)
- * PG-13 and Above (13 years and up)
- * R and Above (restricted)
- * NC-17 and Above (18 years and up)
- * X (adult)

If you set PG-13 and Above ; G and PG movies will be available, PG-13, R, NC-17 and X will be blocked.

For Television programs including made-for-TV movies:

General TV Ratings:

- * Unblocked
- * TV-G and Above (general audience) (individual categories do not apply)
- * TV-PG and Above (parental guidance suggested)
- * TV-14 and Above (14 years and up)
- * TV-MA (mature audience)

Children TV Ratings:

- * Unblocked
- * TV-Y and Above (youth) (individual content categories do not apply)
- * TV-Y7 (youth, 7 years and up)

Content Categories:

- * Dialog - sexual dialogue (applies to TV-PG and Above, TV-14)
- * Language - adult language (applies to TV-PG and Above, TV-14 and Above, TV-MA)
- * Sex scenes - sexual situations (applies to TV-PG and Above, TV-14 and Above, TV-MA)
- * Violence (applies to TV-PG and Above, TV-14 and Above, TV-MA)
- * F Violence - fantasy violence (applies only to TV-Y7)
- * No Rating (blocks all viewing)

(See next page to set blocking.)

Parental control

- 1 Use the **menu** button to select the Special menu.

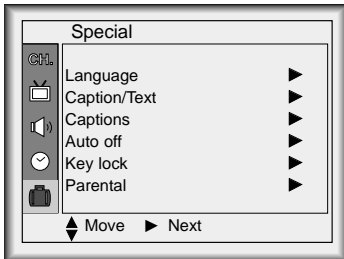

- 3 Press the volume (▶) and then use the channel (▲,▼) buttons to select the desired option.

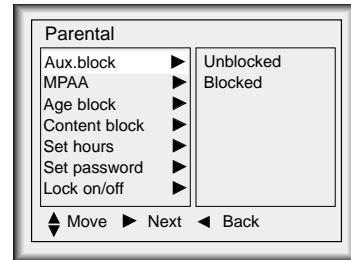

- If Parental is already set then enter the password when requested.

- 2 Press the volume (▶) and then use the channel (▲,▼) buttons to select the Parental option.

- 4 Press the volume (▶) and then use the channel (▲,▼) buttons to select the types of rating to block and then press the **enter** (■) button.

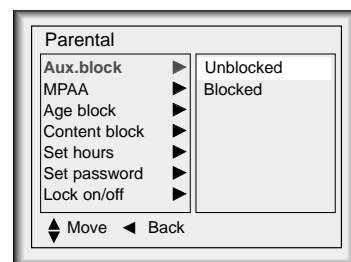

- Age block and Content block options also have sub menus. So repeat steps 3 and 4 in the sub menu to set the type of blocking and rating.

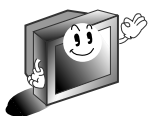

* Select the TV, S-Video and Video mode to use this function.

5 Setting hours for the blocking

Use the channel (▲,▼) buttons to select Set hours and then press the volume (►) button.

Use the channel (▲,▼) buttons to set the number of hours (Up to 99).
Press the **enter** (■) button.

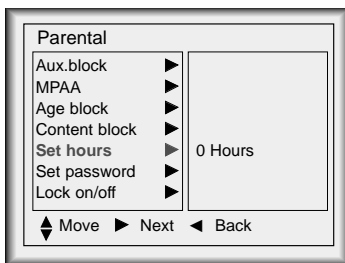

7 Setting lock on/off

Use the channel (▲,▼) buttons to select Lock on/off and then press the volume (►) button.

Use the channel (▲,▼) buttons to select **on** or **off**.
Press the **enter** (■) button.

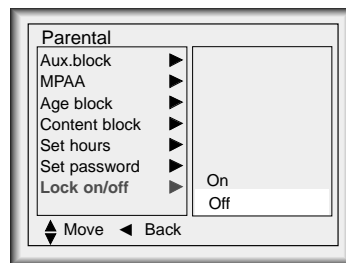

6 Setting Password

Use the channel (▲,▼) buttons to select Set password and then press the volume (►) button.

Enter a four digit password. Enter it again when requested.

- New password may be chosen each time blocking is set up.

Press the **enter** (■) button.

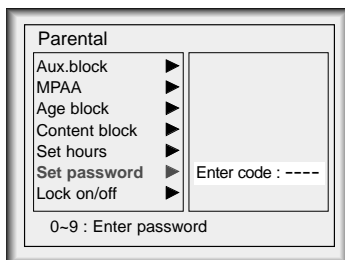

Auto off

* If there is no input signal, the TV switches to standby mode automatically after 10 minutes.

Auto off

- 1 Use the **menu** button to select the Special menu.

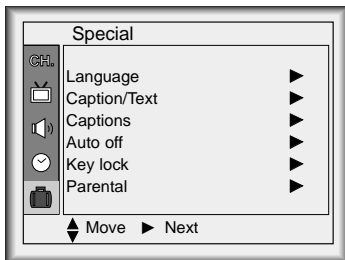

- 3 Press the volume (▶) and then use the channel (▲,▼) buttons to select On or Off.

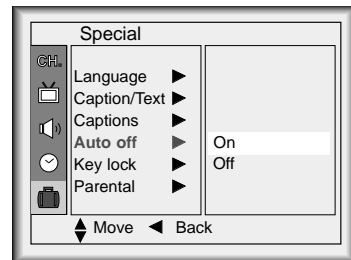

- Each press of channel (▲,▼) buttons toggles between On and Off.



-
- 2 Press the volume (▶) and then use the channel (▲,▼) buttons to select the Auto off option.

-
- 4 Press the **enter** (■) button.

Key Lock

* The TV can be set up so that it can only be used with the remote control.
This feature can prevent unauthorized viewing.

Key lock

- 1 Press the **menu** button to select the screen display as below.

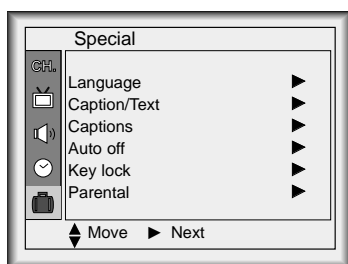

- 2 Press the volume (▶) and then use the channel (▲,▼) buttons to select the Key lock option.

- 3 Press the volume (▶) and then use the channel (▲,▼) buttons to select On or Off.

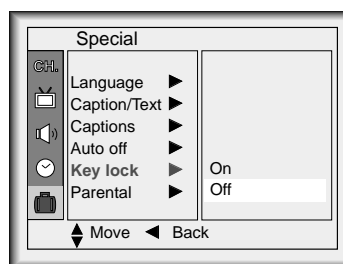

- Each press of channel (▲,▼) buttons toggles between On and Off.



- 4 Press the **enter** (■) button.

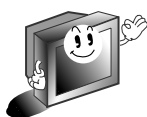

* This TV programmed to remember which option it was last set to even if you turn the TV off.

Product Specifications

Model	:	L15V26
	:	Horizontal size (inch) : 15.28 Height (inch) : 15.17 Thickness (inch) : 6.86 Weight (pound) : 11.68
Power requirements	:	DC 12V/3.5A
		* CAUTION : For use only with Model No. SAD6012SE AC Adapter, manufactured by H & E co., Ltd.
Television system	:	NTSC
Television channels	:	VHF : 2 ~ 13, UHF : 14 ~ 69 Cable : 01 ~ 125
Tube	:	LCD Panel
Power consumption	:	45 W
External antenna impedance	:	75 Ω
Audio output	:	1 W + 1 W
Speaker outputs	:	8 Ω X 2
External input ports	:	1 VIDEO input port set 1 Component (480i/480p/720p/1080i) input set 1 Component audio input set 1 S-VIDEO input 1 Headphone jack 1 PC sound jack 1 PC input jack 1 DC 12V input port set 1 Antenna input
Adapter (DC power)	:	In : AC 100-240V ~ 1.5A-0.6A 50/60Hz, 115~180VA Out : DC 12V, 5A
		* CAUTION : For use only with Model No. SAD6012SE AC Adapter, manufactured by H & E co., Ltd.
Power supply cordset	:	Standard North America three wire earth-grounding with flexible cord SJT type or higher type.
		* CAUTION : If replacement becomes necessary, replace it with an exact duplicate. Contact any Zenith authorized service center.

Maintenance

Caring for your TV

Early malfunctions can be prevented. Careful and regular cleaning can extend the amount of time you will have with your new TV. Be sure to turn the power off and pull out the plug before you begin any cleaning.

Screen Cleaning

1. Here's a great way to keep the dust off your screen for a while. Wet a soft cloth in a mixture of lukewarm water and a little fabric softener or dish washing detergent. Wring the cloth until it's almost dry, and then use it to wipe the screen.
2. Make sure the excess water is off the screen, and then let it air-dry before you turn on your TV.

Cabinet Cleaning

1. Use a soft cloth with a mild soap solution to wipe the cabinet.
2. Rinse the cloth and wipe the cabinet again.
3. Let the cabinet air-dry before turning your TV on.

Extended Absence



If you leave your TV dormant for a long time (such as a vacation), it's a good idea to unplug the power to protect against possible damage from lightning or power surges. If you use an off-air antenna, you may also want to disconnect it from the back of your TV before leaving.

Troubleshooting Check list

SYMPTOMS

No power

No picture or sound

Poor picture but good sound

Poor reception

Lines in picture

Ghosts (multiple images)

Remote control does not work.

Cannot tune desired channel.

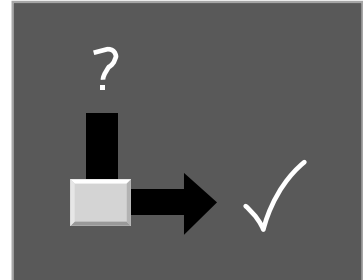

CHECK THESE THINGS

- Is power cord plugged in ?
- Is television turned on ?
- Check batteries in remote control.
- Try another channel (station trouble).
- Check antenna connectings.
- Check for local interference.
- Adjust the antenna.
- Adjust the picture control.
- Program channel using AUTO PROGRAM.

Notes

Empty rectangular box for notes.

206-03777

ZENITH ELECTRONICS CORPORATION LIMITED WARRANTY

Zenith will, at its option, repair or replace your product if it proves to be defective in material or workmanship under normal use during the warranty period listed below from the date of original consumer purchase. The repaired or replacement product will be in warranty for the remainder of the original warranty period. This warranty is good only to the original purchaser of the product during the warranty period as long as it is in the United States, excluding US Territories.

WARRANTY PERIOD

LCD TV	Parts	Labor
Model #: L15V26	One (1) year	One (1) year
Serial #:	Zenith will repair or replace defective product as set forth below	

THIS WARRANTY IS IN LIEU OF ANY OTHER WARRANTIES, EXPRESSED OR IMPLIED, INCLUDING WITHOUT LIMITATION, ANY WARRANTY OF MERCHANTABILITY OR FITNESS FOR A PARTICULAR PURPOSE. TO THE EXTENT ANY IMPLIED WARRANTY IS REQUIRED BY LAW, IT IS LIMITED IN DURATION TO THE EXPRESSED WARRANTY PERIOD ABOVE, AND ZENITH SHALL NOT BE LIABLE FOR ANY CONSEQUENTIAL, INDIRECT, OR INCIDENTAL DAMAGES OF ANY KIND, INCLUDING LOST REVENUES OR PROFITS, IN CONNECTION WITH THE PRODUCT. SOME STATES DO NOT ALLOW LIMITATION ON HOW LONG AN IMPLIED WARRANTY LASTS OR THE EXCLUSION OF INCIDENTAL OR CONSEQUENTIAL DAMAGES, SO THE ABOVE LIMITATIONS OR EXCLUSIONS MAY NOT APPLY TO YOU.

THE ABOVE WARRANTY DOES NOT APPLY TO:

1. Damages or problems that result from shipping, installation, maintenance, or separate system components; and
2. Damages or problems that result from misuse, abuse, operation outside environmental specifications or contrary to the requirements or precautions in the Operating Guide, accident, lightning strikes or other natural causes, unauthorized modification or alteration, incorrect electrical current or voltage, other causes not arising out of defect in material or workmanship, or institutional or commercial use.
3. Therefore, the cost of repair or replacement of such defective product shall be borne by the customer.

REPAIR OR REPLACEMENT OF DEFECTIVE PRODUCT:

For RMA and Return of Defective Product for Warranty Service	Call 1-800-984-9349 (24 hours a day, 365 days per year) for Return Merchandise Authorization (RMA) and your returning defective product for repair/replacement. The defective product must be packaged in original box and a copy of original bill of sale must be included.
Warranty Repair or Replacement	Upon receipt by Zenith of the defective product under RMA, Zenith will repair and ship, freight prepaid, repaired or replacement product to you.
For Post Warranty Repair	For repair or replacement after Warranty has expired, Call 1-800-984-9349 (24 hours a day, 365 days per year)
For Product Assistance, or Customer Assistance	Call 1-877-993-6484 (1-877-9ZENITH) (24 hours a day, 365 days per year) Or visit our website at http://www.zenithservice.com

Retain your Sales Receipt to prove Date of Purchase, and Original Packaging Material for shipping defective product for repair when needed.